



# PLPE

## The cost effective planetary gearbox with the best torque-low heat performance

Our **PLPE** combines the best features of the Economy series with a performance bonus: The optimized output bearing is designed for higher radial and axial forces. The compact outer contour of the PLPE also allows it to be used in limited spaces.

Nominal output torque **5 - 460 Nm**

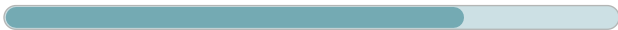

Radial force **800 - 5200 N**

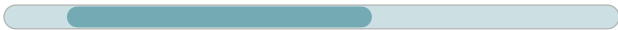

Axial force **1000 - 7000 N**



Torsional backlash **7 - 19 arcmin**



Protection class **IP54**



Frame sizes

- 50
- 70
- 90
- 120
- 155

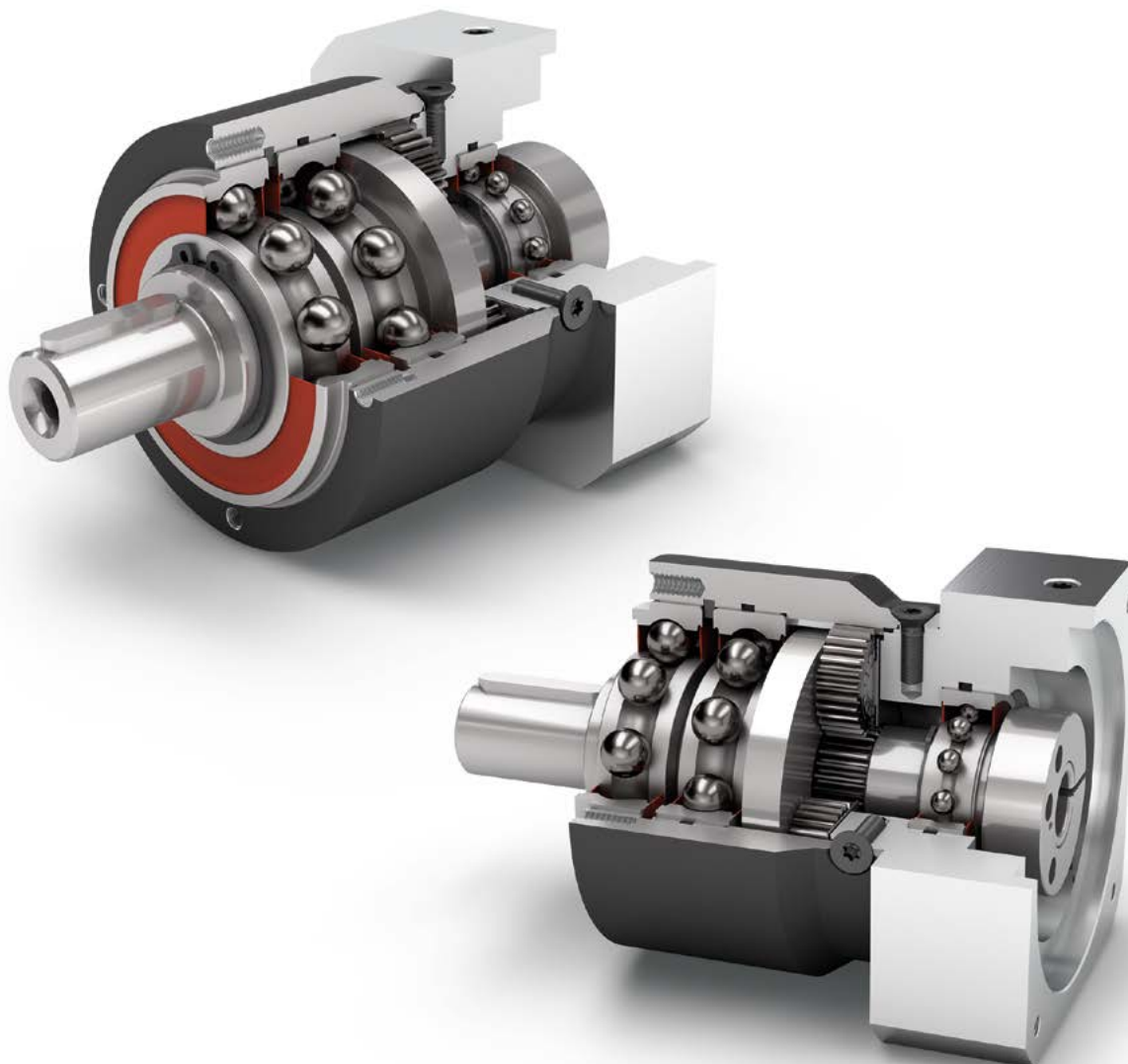

Economy Line

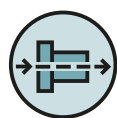

Coaxial gearbox



Spur gear



Reinforced deep groove ball bearings

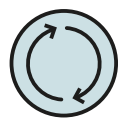

Equidirectional rotation

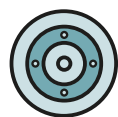

Round type output flange



Planet carrier in disc design

Detailed explanations of the technical features starting on page 171.

PLPE

Code	Gearbox characteristics			PLPE050	PLPE070	PLPE090	PLPE120	PLPE155	p <sup>(1)</sup>
	Service life (L <sub>10h</sub> )	t <sub>L</sub>	h	30,000					
	Efficiency at full load <sup>(2)</sup>	η	%	98					1
				97					2
	Min. operating temperature	T <sub>min</sub>	°C	-25 (-13)					
	Max. operating temperature	T <sub>max</sub>	(°F)	90 (194)					
	Protection class	IP54							
<b>S</b>	Standard lubrication	Grease (lifetime lubrication)							
<b>F</b>	Food grade lubrication	Grease (lifetime lubrication)							
<b>L</b>	Low temperature lubrication <sup>(3)</sup>	Grease (lifetime lubrication)							
	Installation position	Any							
<b>S</b>	Standard backlash	j <sub>t</sub>	arcmin	< 15	< 10	< 7	< 7	< 6	1
				< 19	< 12	< 9	< 9	< 9	2
	Torsional stiffness <sup>(2)</sup>	c <sub>g</sub>	Nm /arcmin (lb <sub>r</sub> .in/ arcmin)	0.7 - 1.0 (6 - 9)	3.5 - 5.6 (31 - 50)	9.7 - 15.0 (86 - 133)	24.5 - 39.5 (217 - 350)	54.5 - 71.0 (482 - 628)	1
				0.7 - 1.1 (6 - 9)	3.3 - 5.8 (29 - 51)	9.7 - 16.1 (86 - 142)	21.0 - 43.5 (186 - 385)	55.0 - 73.0 (487 - 646)	2
	Gearbox weight <sup>(2)</sup>	m <sub>G</sub>	kg (lb <sub>m</sub> )	0.6 (1.3)	1.4 (3.1)	3.2 - 3.3 (7.1 - 7.3)	7.4 - 7.5 (16.3 - 16.6)	16.8 (37.0)	1
				0.8 - 1.1 (1.7 - 2.4)	1.7 - 1.9 (3.7 - 4.1)	3.9 - 4.0 (8.6 - 8.9)	9.3 - 9.6 (20.6 - 21.3)	22.1 - 22.5 (48.8 - 49.6)	2
<b>S</b>	Standard surface	Housing: Steel – heat-treated and post-oxidized (black)							
	Running noise <sup>(4)</sup>	Q <sub>g</sub>	dB(A)	58	58	60	65	70	
	Max. bending moment based on the gearbox input flange <sup>(5)</sup>	M <sub>b</sub>	Nm (lb <sub>r</sub> .in)	4,5 (40)	12 (106)	16 (142)	40 (354)	180 (1593)	

Output shaft loads			PLPE050	PLPE070	PLPE090	PLPE120	PLPE155	p <sup>(1)</sup>
Radial force for 20,000 h <sup>(6)(7)</sup>	F <sub>r20.000h</sub>	N (lb <sub>r</sub> )	800 (180)	1050 (236)	1900 (427)	2500 (562)	5200 (1169)	
Axial force for 20,000 h <sup>(6)(7)</sup>	F <sub>a20.000h</sub>		1000 (225)	1350 (303)	2000 (450)	4000 (899)	7000 (1574)	
Radial force for 30,000 h <sup>(6)(7)</sup>	F <sub>r30.000h</sub>		700 (157)	900 (202)	1700 (382)	2150 (483)	4600 (1034)	
Axial force for 30,000 h <sup>(6)(7)</sup>	F <sub>a30.000h</sub>		800 (180)	1000 (225)	1500 (337)	3000 (674)	6000 (1349)	
Maximum radial force <sup>(7)(8)</sup>	F <sub>rStat</sub>		1300 (292)	1650 (371)	3100 (697)	4000 (899)	8400 (1888)	
Maximum axial force <sup>(7)(8)</sup>	F <sub>aStat</sub>		1000 (225)	2100 (472)	3800 (854)	5900 (1326)	11000 (2473)	
Tilting moment for 20,000 h <sup>(6)(8)</sup>	M <sub>K20.000h</sub>	Nm (lb <sub>r</sub> .in)	26 (230)	42 (372)	99 (876)	168 (1487)	497 (4399)	
Tilting moment for 30,000 h <sup>(6)(8)</sup>	M <sub>K30.000h</sub>		22 (195)	36 (319)	89 (788)	144 (1275)	440 (3894)	

Moment of inertia			PLPE050	PLPE070	PLPE090	PLPE120	PLPE155	p <sup>(1)</sup>
Mass moment of inertia <sup>(2)</sup>	J	kgcm <sup>2</sup> (lb <sub>r</sub> .in.s <sup>2</sup> 10 <sup>-4</sup> )	0.015 - 0.030 (0.133 - 0.266)	0.069 - 0.174 (0.611 - 1.540)	0.374 - 0.789 (3.310 - 6.983)	1.419 - 2.764 (12.559 - 24.463)	4.932 - 7.611 (43.652 - 67.363)	1
			0.014 - 0.026 (0.124 - 0.230)	0.064 - 0.126 (0.566 - 1.115)	0.356 - 0.625 (3.151 - 5.532)	1.376 - 2.334 (12.179 - 20.658)	4.759 - 7.108 (42.121 - 62.911)	2

(1) Number of stages  
 (2) The ratio-dependent values can be retrieved in Tec Data Finder – www.neugart.com  
 (3) T<sub>min</sub> = -40°C. Optimal operating temperature max. 50°C  
 (4) Sound pressure level from 1 m, measured on input running at n<sub>i</sub>=3000 rpm no load; i=5  
 (5) Max. motor weight\* in kg = 0.2 x M<sub>b</sub> / motor length in m  
 \* with symmetrically distributed motor weight  
 \* with horizontal and stationary mounting  
 (6) These values are based on an output shaft speed of n<sub>2</sub>=100 rpm  
 (7) Based on center of output shaft  
 (8) Other (sometimes higher) values following changes to T<sub>2n</sub>, F<sub>r</sub>, F<sub>a</sub>, cycle, and service life of bearing. Application specific configuration with NCP – www.neugart.com

Output torques			PLPE050	PLPE070	PLPE090	PLPE120	PLPE155	i <sup>(1)</sup>	p <sup>(2)</sup>
Nominal output torque <sup>(3)(4)</sup>	T <sub>2N</sub>	Nm (lb.in)	11 (97)	28 (248)	85 (752)	115 (1018)	-	3	1
			15 (133)	33 (292)	90 (797)	155 (1372)	460 (4071)	4	
			13 (115)	30 (266)	82 (726)	172 (1522)	445 (3939)	5	
			8,5 (75)	25 (221)	65 (575)	135 (1195)	-	7	
			6 (53)	18 (159)	50 (443)	120 (1062)	-	8	
			5 (44)	15 (133)	38 (336)	95 (841)	210 (1859)	10	
			12 (106)	33 (292)	97 (859)	157 (1390)	-	9	2
			15 (133)	33 (292)	90 (797)	195 (1726)	-	12	
			13 (115)	33 (292)	82 (726)	172 (1522)	-	15	
			15 (133)	33 (292)	90 (797)	195 (1726)	460 (4071)	16	
			15 (133)	33 (292)	90 (797)	195 (1726)	460 (4071)	20	
			13 (115)	30 (266)	82 (726)	172 (1522)	445 (3939)	25	
			15 (133)	33 (292)	90 (797)	195 (1726)	-	32	
			13 (115)	30 (266)	82 (726)	172 (1522)	460 (4071)	40	
			-	-	-	-	445 (3939)	50	
			7,5 (66)	18 (159)	50 (443)	120 (1062)	-	64	
			5 (44)	15 (133)	38 (336)	95 (841)	210 (1859)	100	
			Max. output torque <sup>(4)(5)</sup>	T <sub>2max</sub>	Nm (lb.in)	17,5 (155)	45 (398)	136 (1204)	
24 (212)	53 (469)	144 (1275)				248 (2195)	736 (6514)	4	
21 (186)	48 (425)	131 (1159)				275 (2434)	712 (6302)	5	
13,5 (119)	40 (354)	104 (920)				216 (1912)	-	7	
9,5 (84)	29 (257)	80 (708)				192 (1699)	-	8	
8 (71)	24 (212)	61 (540)				152 (1345)	336 (2974)	10	
19 (168)	53 (469)	155 (1372)				251 (2222)	-	9	2
24 (212)	53 (469)	144 (1275)				312 (2761)	-	12	
21 (186)	53 (469)	131 (1159)				275 (2434)	-	15	
24 (212)	53 (469)	144 (1275)				312 (2761)	736 (6514)	16	
24 (212)	53 (469)	144 (1275)				312 (2761)	736 (6514)	20	
21 (186)	48 (425)	131 (1159)				275 (2434)	712 (6302)	25	
24 (212)	53 (469)	144 (1275)				312 (2761)	-	32	
21 (186)	48 (425)	131 (1159)				275 (2434)	736 (6514)	40	
-	-	-				-	712 (6302)	50	
12 (106)	29 (257)	80 (708)				192 (1699)	-	64	
8 (71)	24 (212)	61 (540)				152 (1345)	336 (2974)	100	

PLPE

(1) Ratios (i=n<sub>1</sub>/n<sub>2</sub>)  
 (2) Number of stages  
 (3) Application specific configuration with NCP – www.neugart.com  
 (4) Values for feather key (code "A"): for repeated load  
 (5) 30,000 rotations of the output shaft permitted; see page 164

PLPE

Output torques			PLPE050	PLPE070	PLPE090	PLPE120	PLPE155	i <sup>(1)</sup>	p <sup>(2)</sup>
Emergency stop torque <sup>(3)</sup>	T <sub>2Stop</sub>	Nm (lb <sub>f</sub> .in)	22,5 (199)	66 (584)	180 (1593)	390 (3452)	-	3	1
			30 (266)	88 (779)	240 (2124)	520 (4602)	920 (8143)	4	
			36 (319)	80 (708)	220 (1947)	500 (4425)	890 (7877)	5	
			26 (230)	80 (708)	178 (1575)	340 (3009)	-	7	
			27 (239)	80 (708)	190 (1682)	380 (3363)	-	8	
			27 (239)	80 (708)	200 (1770)	480 (4248)	420 (3717)	10	
			33 (292)	88 (779)	260 (2301)	500 (4425)	-	9	
		40 (354)	88 (779)	240 (2124)	520 (4602)	-	12	2	
		36 (319)	88 (779)	220 (1947)	500 (4425)	-	15		
		40 (354)	88 (779)	240 (2124)	520 (4602)	920 (8143)	16		
		40 (354)	88 (779)	240 (2124)	520 (4602)	920 (8143)	20		
		36 (319)	80 (708)	220 (1947)	500 (4425)	890 (7877)	25		
		40 (354)	88 (779)	240 (2124)	520 (4602)	-	32		
		36 (319)	80 (708)	220 (1947)	500 (4425)	920 (8143)	40		
		-	-	-	-	890 (7877)	50		
		27 (239)	80 (708)	190 (1682)	380 (3363)	-	64		
		27 (239)	80 (708)	200 (1770)	480 (4248)	420 (3717)	100		

Input speeds			PLPE050	PLPE070	PLPE090	PLPE120	PLPE155	i <sup>(1)</sup>	p <sup>(2)</sup>
Average thermal input speed at T <sub>2N</sub> and S1 <sup>(4)(5)</sup>	n <sub>1N</sub>	rpm	5000	4500 <sup>(6)</sup>	3250 <sup>(6)</sup>	2650 <sup>(6)</sup>	-	3	1
			5000	4500 <sup>(6)</sup>	3750 <sup>(6)</sup>	2800 <sup>(6)</sup>	1800 <sup>(6)</sup>	4	
			5000	4500	4000 <sup>(6)</sup>	3100 <sup>(6)</sup>	2150 <sup>(6)</sup>	5	
			5000	4500	4000	3500 <sup>(6)</sup>	-	7	
			5000	4500	4000	3500	-	8	
			5000	4500	4000	3500	3000	10	
			5000	4500	4000 <sup>(6)</sup>	3500 <sup>(6)</sup>	-	9	
			5000	4500	4000	3500 <sup>(6)</sup>	-	12	2
			5000	4500	4000	3500 <sup>(6)</sup>	-	15	
			5000	4500	4000	3500 <sup>(6)</sup>	2900 <sup>(6)</sup>	16	
			5000	4500	4000	3500	3000 <sup>(6)</sup>	20	
			5000	4500	4000	3500	3000 <sup>(6)</sup>	25	
			5000	4500	4000	3500	-	32	
			5000	4500	4000	3500	3000	40	
			-	-	-	-	3000	50	
			5000	4500	4000	3500	-	64	
			5000	4500	4000	3500	3000	100	
Max. mechanical input speed <sup>(4)</sup>	n <sub>1Limit</sub>	rpm	18000	13000	7000	6500	5500		1
			18000	13000	7000	6500	5500		2

<sup>(1)</sup> Ratios (i=n<sub>1</sub>/n<sub>2</sub>)

<sup>(2)</sup> Number of stages

<sup>(3)</sup> Permitted 1000 times

<sup>(4)</sup> Application-specific speed configurations with NCP – www.neugart.com

<sup>(5)</sup> See page 164 for the definition

<sup>(6)</sup> Average thermal input speed at 50% T<sub>2N</sub> and S1

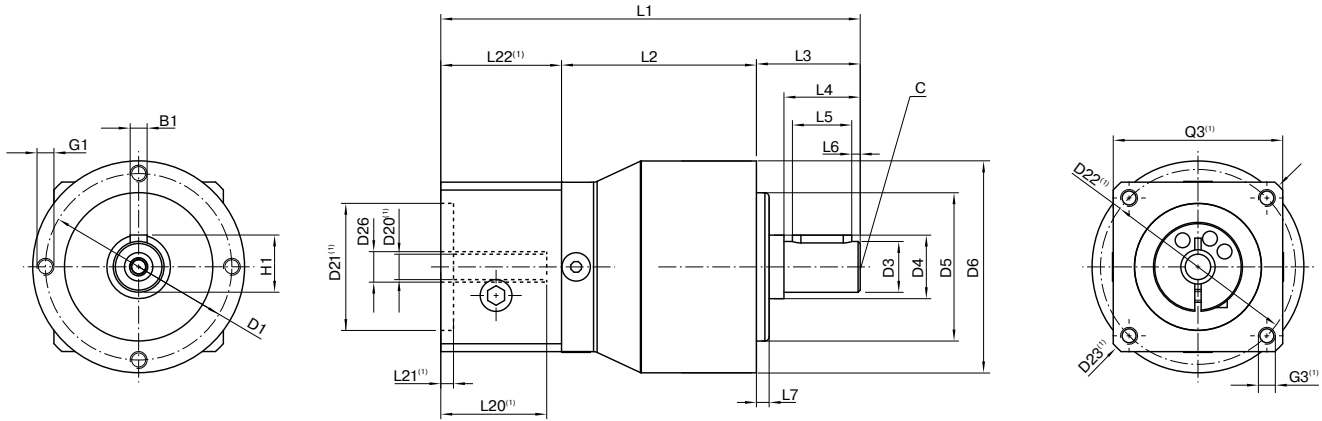

Drawing corresponds to a PLPE050 / 1-stage / output shaft with feather key / 8 mm clamping system / motor adaptation – one part / B5 flange type motor

<sup>(1)</sup> The dimensions vary with the motor/gearbox flange. The input flange dimensions can be retrieved for each specific motor in Tec Data Finder at [www.neugart.com](http://www.neugart.com)

Geometry <sup>(2)</sup>			PLPE050	PLPE070	PLPE090	PLPE120	PLPE155	p <sup>(3)</sup>	Code
Pitch circle diameter output	D1		44 (1.732)	62 (2.441)	80 (3.150)	108 (4.252)	140 (5.512)		
Shaft diameter output	D3	k7	12 (0.472)	16 (0.630)	22 (0.866)	32 (1.260)	40 (1.575)		
Shaft collar output	D4		15 (0.591)	30 (1.181)	35 (1.378)	50 (1.969)	55 (2.165)		
Centering diameter output	D5	h7	35 (1.378)	52 (2.047)	68 (2.677)	90 (3.543)	120 (4.724)		
Housing diameter	D6		50 (1.969)	70 (2.756)	90 (3.543)	120 (4.724)	155 (6.102)		
Mounting thread x depth	G1	4x	M4x8	M5x8	M6x9	M8x20	M10x20		
Min. total length	L1		94 (3.701)	111 (4.370)	147 (5.787)	192 (7.559)	275.5 (10.846)	1	
			106.5 (4.193)	124 (4.882)	165 (6.496)	219.5 (8.642)	320 (12.598)	2	
Housing length	L2		46 (1.811)	51 (2.008)	67.5 (2.657)	76.5 (3.012)	100 (3.937)	1	
			58.5 (2.303)	64 (2.520)	85 (3.346)	104 (4.094)	144.5 (5.689)	2	
Shaft length output	L3		24.5 (0.965)	36 (1.417)	46 (1.811)	68 (2.677)	97 (3.819)		
Centering depth output	L7		3 (0.118)	3 (0.118)	4 (0.157)	5 (0.197)	8 (0.315)		
Motor shaft diameter j6/k6	D20		More information on page 161/162						
Clamping system diameter input	D26		More information on page 161/162						
Output shaft with feather key (DIN 6885-1)			A 4x4x14	A 5x5x25	A 6x6x32	A 10x8x50	A 12x8x70		
Feather key width (DIN 6885-1)	B1		4 (0.157)	5 (0.197)	6 (0.236)	10 (0.394)	12 (0.472)		A
Shaft height including feather key (DIN 6885-1)	H1		13.5 (0.531)	18 (0.709)	24.5 (0.965)	35 (1.378)	43 (1.693)		
Shaft length from shoulder	L4		18 (0.709)	28 (1.102)	36 (1.417)	58 (2.283)	82 (3.228)		
Feather key length	L5		14 (0.551)	25 (0.984)	32 (1.260)	50 (1.969)	70 (2.756)		
Distance from shaft end	L6		2 (0.079)	2 (0.079)	2 (0.079)	4 (0.157)	6 (0.236)		
Center hole (DIN 332, type DR)	C		M4x10	M5x12.5	M8x19	M12x28	M16x36		
Smooth output shaft									B
Shaft length from shoulder	L4		18 (0.709)	28 (1.102)	36 (1.417)	58 (2.283)	82 (3.228)		

<sup>(2)</sup> Dimensions in mm

<sup>(3)</sup> Number of stages